

Touch interface

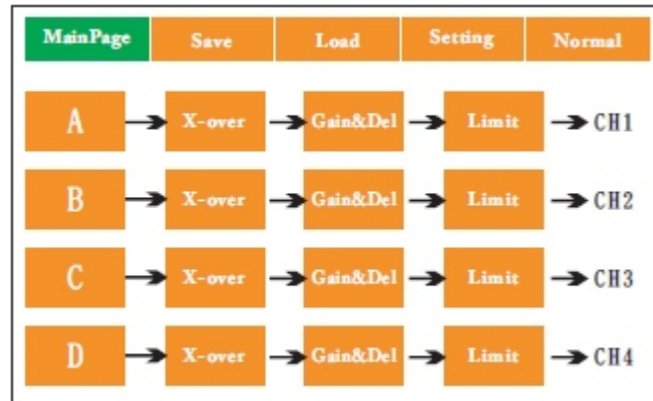

Main Page



Output parameters setting



Save Page

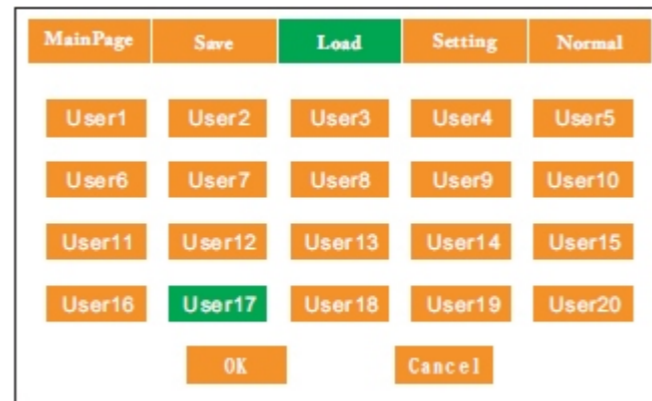

Load Page

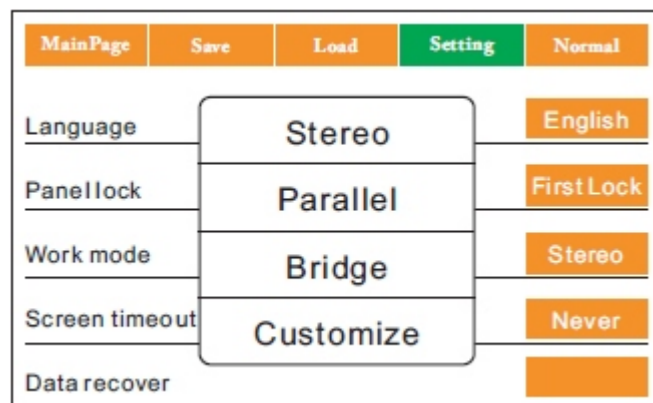

Setting Page

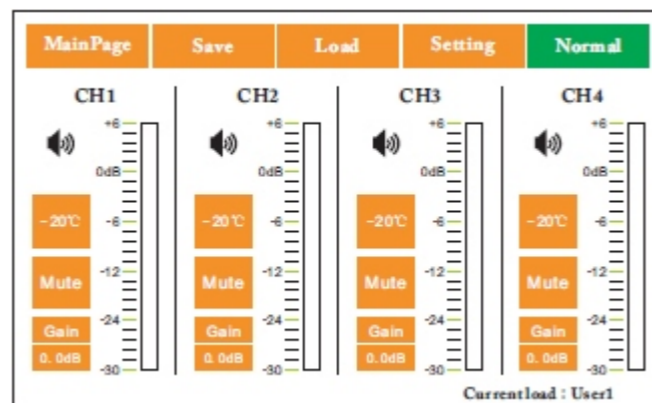

Normal Page

Contents and Specification

Contents and Specification.....	1
Important note.....	2
Control elements and PC Interface.....	3
Rear panel features introduction.....	4
Rear panel features introduction.....	5
Audio input and output connections.....	6
PC Interface.....	7
Touch interface.....	8

SPECIFICATION

DSP	
MODEL:	DP10Q
Input:	4 channel
Output:	4 channel
PC Com Port:	1 USB Com Port on front panel, 2 RS485 Com Port on back panel (RJ-45)
Processor:	96KHz Sampling frequency, 32-bit Floating-Point DSP, 24-bit A/D and D/A converter
Dynamic range:	>110dB
Frequency Response:	±0.25dB, 20Hz--20KHz
Distortion:	< 0.01%, 20Hz - 20KHz
Signal to noise ratio:	>110dB
crossover filter:	Each output channel can be independently set as LPF and HPF, The parameters can be adjusted, Filter type: Butterworth, Bessel, Linkwitz-Riley; The Crossover Frequency: 20Hz--20KHz, Slope: 12, 24, 36 or 48 dB/octave
EQ:	Frequency: 20Hz to 20KHz, Gain: -20dB to +10dB, step: 0.1 dB
Delay:	0ms to 1000ms
Display:	4inch Touch screen
Store Settings:	20 user program dynamic storage

AMPLIFIER

Model	DP 10Q
Output Power	
8 Ω Stereo Power	4×1300W
4 Ω Stereo Power	4×2200W
2 Ω Stereo Power	4×2500W
8 Ω Bridged Monon Power	2×4400W
4 Ω Bridged Monon Power	2×5000W
Frequency Response	20Hz-20kHz ±0.5dB
THD+N(Rated power, 4Ω/KHz)%	0.10%
Signal Noise Ratio(dB)	110dB
Input Impedance	20KΩ Balanced / 10kΩ Unbalanced
Output Connectors	Speakon Connectors(NEUTRIK)
Power Requirement	100-120V-50-60Hz or 200-240V-50-60Hz

Dimension	
Airframe	483×377×88mm
Weight	
Weight(net)	13Kg

Important Note

WARNING NOTICES

SAFEGUARDS

Electrical energy can perform many useful functions, This unit has been engineered and manufactured to assure your personal safety. Improper use can result in potential electrical shock or fire hazards. In order not to defeat the safeguards, observe the following precautions for its installation, use and servicing.

Explanation of Graphical Symbols



**CAUTION
RISK OF ELECTRIC SHOCK
DO NOT OPEN**



**CAUTION
RISK OF ELECTRIC SHOCK :
OPEN ONLY IF QUALIFIED
AS SERVICE PERSONNEL**

**WARNING: TO PREVENT FIRE OR ELECTRIC SHOCK, DO NOT EXPOSE
THIS EQUIPMENT TO RAIN OR MOISTURE**

IMPORTANT NOTE

ATTENTION: This unit must be protected from damp because of the risk of fire and the possibility of electric shocks.

1. Make sure that you have the correct mains voltage. Only operate the unit at the mains voltage marked on the rear panel.
2. Make sure that nothing especially no metal objects are inserted into the device. This could result in electric shock or malfunction.
3. If the unit is subjected to extreme fluctuations of temperature e.g. On being transported from outside into a heated room, condensation can form. This unit should not be used until it has reached room temperature.
4. In the event of water or any other fluid being accidentally spilt on the unit switch the unit off immediately and send it to a qualified service workshop for inspection.
5. Make sure that the unit is always well ventilated and never exposed to direct sunlight
6. Do not use sprays to clean the unit as they have a detrimental effect on the unit and could ignite suddenly.
7. The machine use single power switch, please cut off the power before fix.
8. Please do not put the cup, vessel of flower or container above the machine, in case the leak out water then cause the leakage current off the machine.

PC Interface

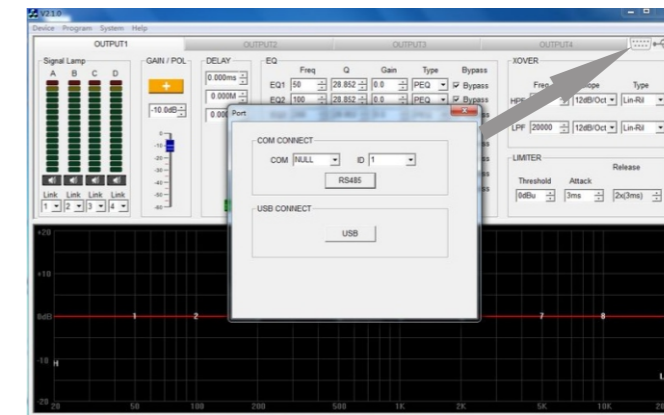

Connection type

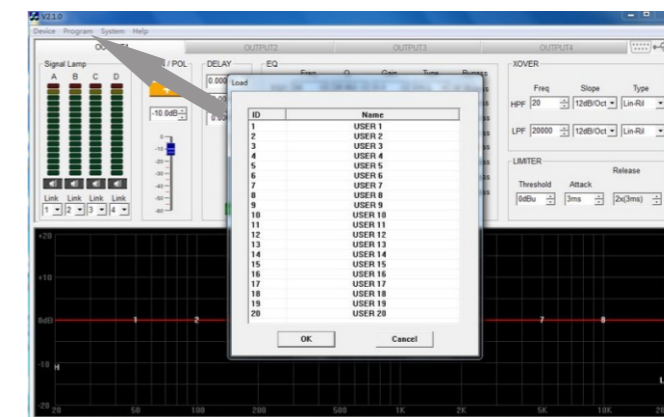

Load/save/import/export interface

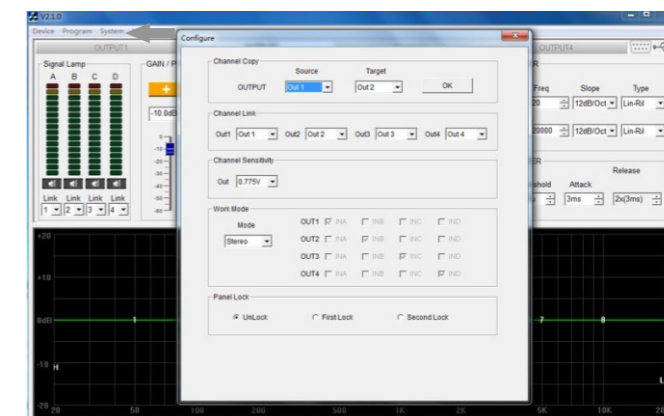

System parameter selection interface

Audio input and output connections

Work Mode

Work Mode

Mode

Customize

OUT1	<input checked="" type="checkbox"/> INA	<input type="checkbox"/> INB	<input type="checkbox"/> INC	<input type="checkbox"/> IND
OUT2	<input type="checkbox"/> INA	<input checked="" type="checkbox"/> INB	<input type="checkbox"/> INC	<input type="checkbox"/> IND
OUT3	<input type="checkbox"/> INA	<input type="checkbox"/> INB	<input checked="" type="checkbox"/> INC	<input type="checkbox"/> IND
OUT4	<input type="checkbox"/> INA	<input type="checkbox"/> INB	<input type="checkbox"/> INC	<input checked="" type="checkbox"/> IND

Stereo Mode

The signal input into channel 1 can be output from channel 1 only, similarly, the signal input into channel 2 can be output from channel 2 only. The many channels, one by one in order type pushes.

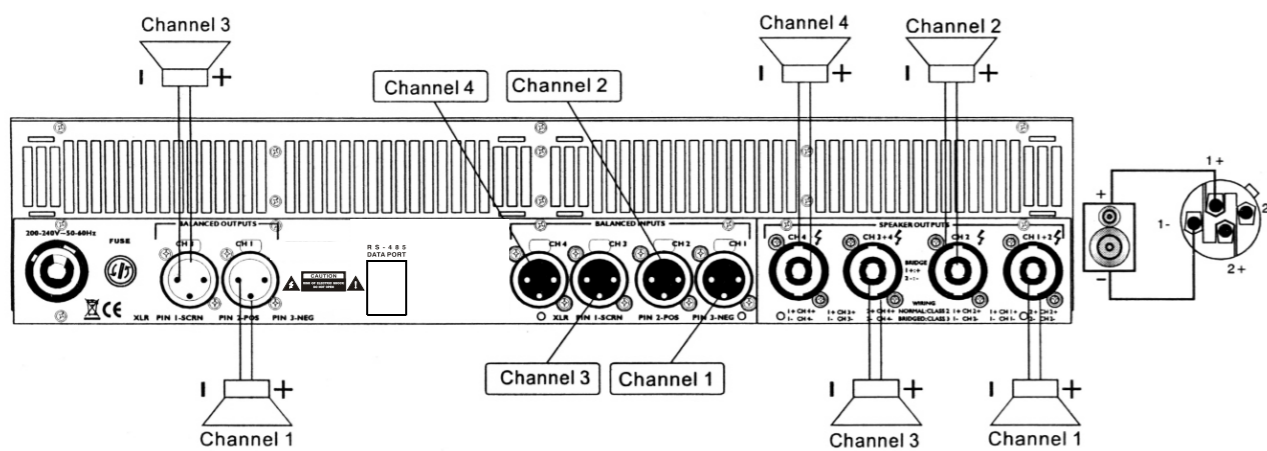

Bridge Mode

channel 1 and channel 2 are bridged, channel 3 and channel 4 are bridged.

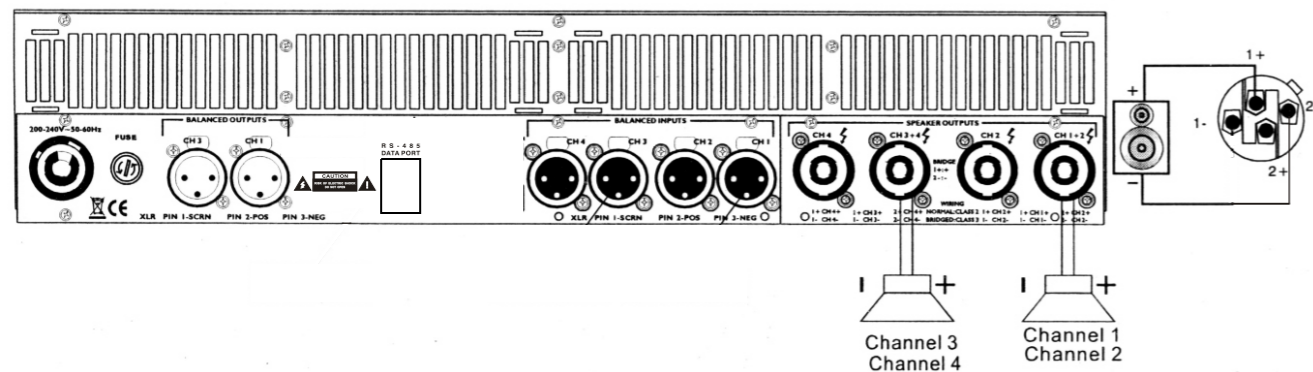

Control elements and PC Interface

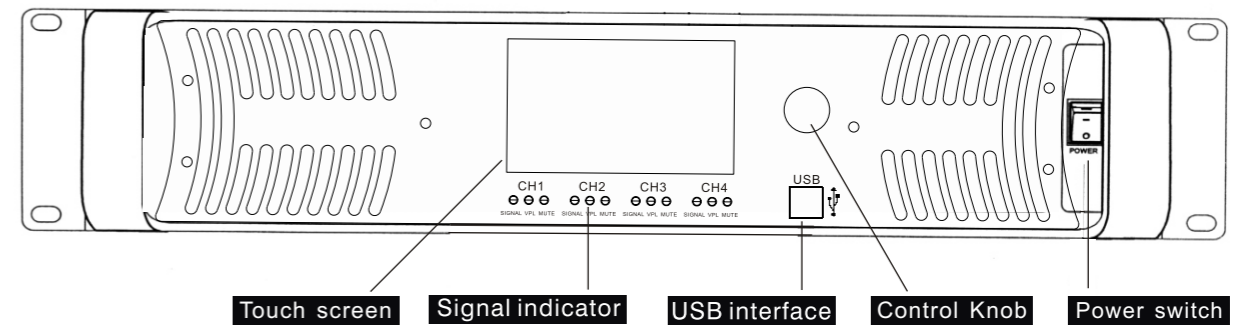

Touch screen

Display and adjust parameters.

Signal indicator

SIGNAL LED: Indicate output signal levels in normal operating range
 VPL LED: This indicator signals if the amplifier output is clipping or limiting.
 CPL LED: Low impedance/Short Circuit Detection Fault
 MUTE LED: MUTE-Audio protection under mute position.

USB interface

Use a USB cable to connect the machine and PC

Control Knob

Set parameters in edit state

Power switch

Turn the unit power on or off.

PC Interface

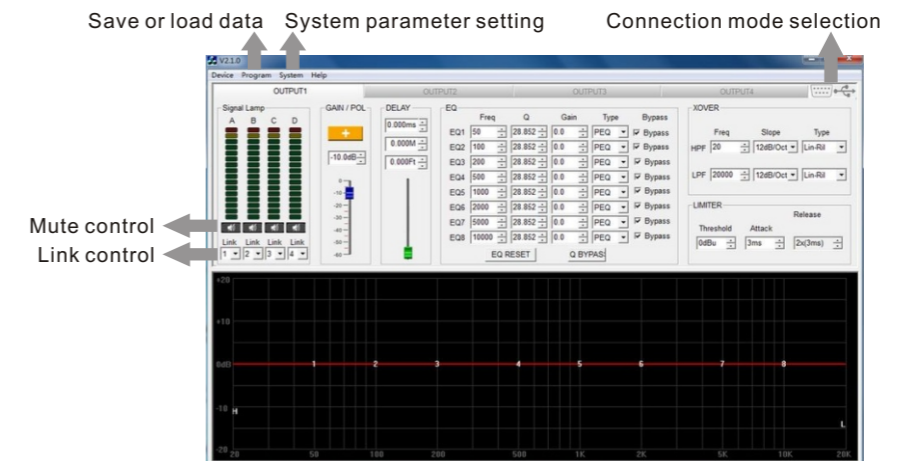

Rear panel features introduction

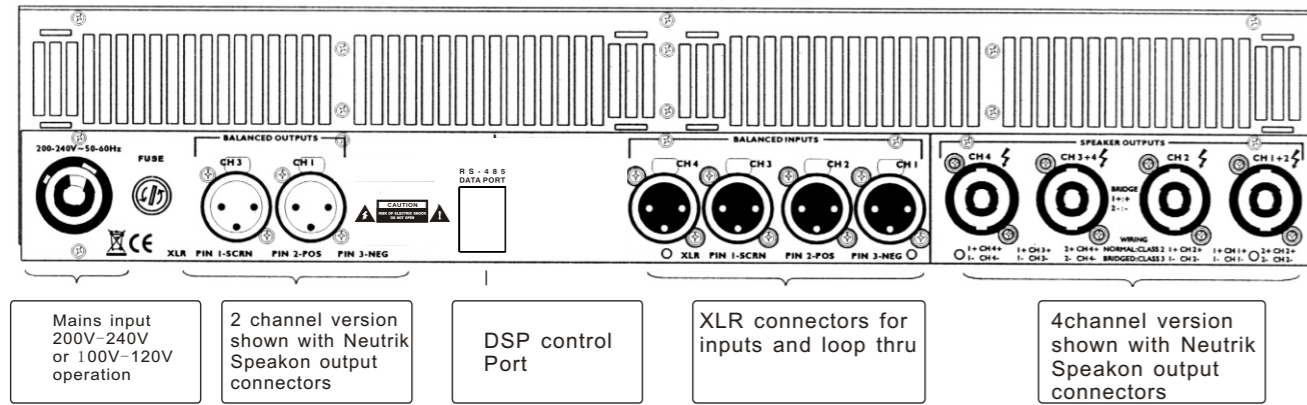

Input Connectors

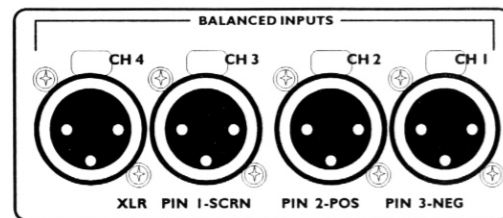

Audio inputs-4-channel models

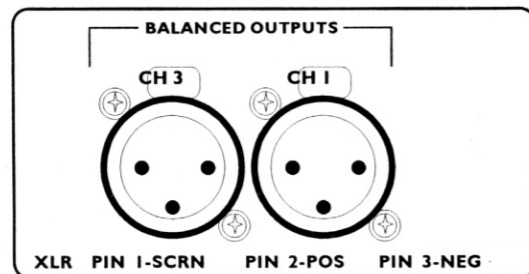

Audio link:

the signal input into channel 1 can be output from channel 1 only, similarly, the signal channel 3 is the same.

Output Connectors

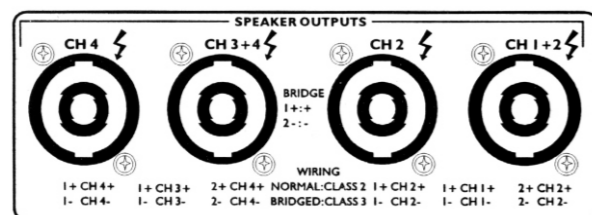

Rear panel features introduction

Speakon outputs-4-channel models

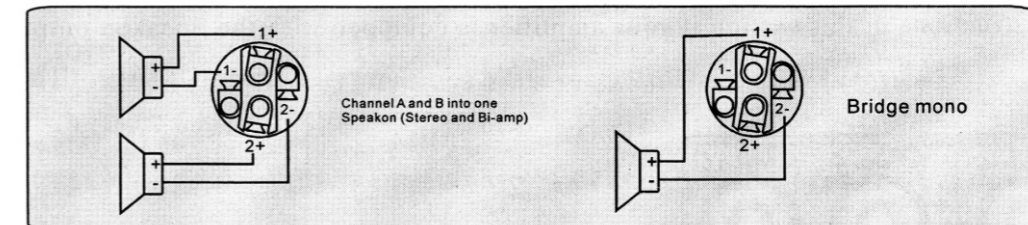

Four-channel amplifiers Additional connectors are provided for channel 3 and channel 4. Channel 3 functions as channel 1 above, and channel 4 as channel 2 above.

BALANCED INPUT CONNECTIONS

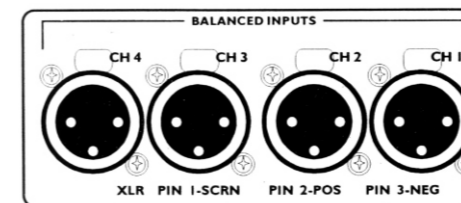

Audio input-4-channel models

The XLR input connectors are electronically balanced, and wired according to the IEC 268 standard (pin 2= hot). XLR input connectors should be wired follows:

- Pin 1 Ground/Shield
- Pin 2 Hot (+)
- Pin 3 Cold (-)

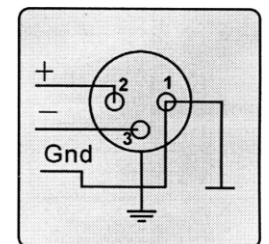

When linking the same source signal to several input channels, be aware that there is a limit to the number of channels an output source can "drive". A typical output source (e.g. a DSP crossover unit) can drive up to four amplifier channels before external line-drivers might be required to buffer the signal.

Unbalanced Input connections

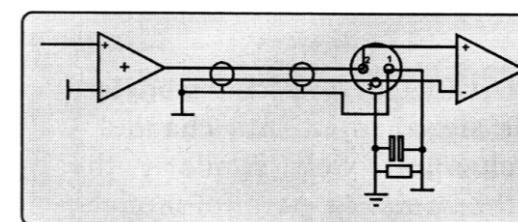

To connect an input to an unbalanced source, it is possible to connect pins 1 and 3 in the XLR plug at the amplifier end of the cable. However, a better method is to connect pin 3 to the shield at the source end of the cable, as this usually results in better hum and noise rejection. Balanced input connections are recommended whenever possible